

**KUSAM-MECO**

# DIGITAL CLAMP METER MODEL - 2718



**KUSAM-MECO**

**TAKE MEASUREMENT CAREFULLY AND YOU'LL  
SPARE YOUR METER AND YOURSELF, SOME PAIN**

Nearly every electrical engineer has a hand held digital clamp meter (Tongtester). We sometimes take them for granted, until we damage them or "burn them out". If you incorrectly connect your clamp meter to a circuit, or if you have the clamp meter or wrong setting, you damage the meter and possibly hurt yourself. You can also get into trouble if you try to measure the voltage across a charged capacitor.

Clamp meter users frequently burn their meters by trying to measure current the same way as they measure voltage. Remember, you measure voltage across a circuit, and current through a circuit. When you use the current input, your clamp meter becomes a low impedance circuit element.

Even if you correctly insert your clamp meter in to the circuit, you can still damage you meter. Don't try to measure current in excess of your meter's capacity. Check the current capacity of the Clamp meter.

If you are measuring current in industrial environment to prevent excess disconnect your test leads from the circuit under test whenever you change Clamp meter functions. Set your meter to the correct function, say current, and its highest range for the setting. If the reading is small, change the range to the next lower range till the reading can be read with the best possible accuracy. When measuring voltage, connect the test leads before your apply power to your circuit. To be safe, start by setting your meter to its highest range first.

## Overview

This operating Manual covers information on safety and cautions. Please read the relevant information carefully and observe all the warnings and Notes strictly.



### Warning

**To avoid electric shock or personal injury, read the “Safety Information” and “Rules for Safe Operation” carefully before using the Meter.**

Digital Clammeter Model - 2718 (hereafter referred to as “the Meter”) is a 3½ digits Clammeter with steady operations, and highly reliable **hand-held** measuring instrument. The Clammeter uses large scale of integrated circuit with double integrated A/D converter as its core and has full range overload protection.

The Meter can measure AC/DC Voltage, AC Current, Resistance, Temperature (°F / °C) but also has Data-Hold, Diodes, Continuity and so on.

## Terms in this manual



**Warning :** identifies conditions and actions that could result in serious injury or even death to the user.



**Caution :** identifies conditions and action that could cause damage or malfunction in the instrument.

## Unpacking Inspection

















Open the package case and take out the Clamp Meter. Check the following items carefully to see any missing or damaged part :

Item	Description	Qty.
1	English Operating Manual	1 No.
2	Test Lead	1 pair
3	Temperature Probe	1 No.
4	1.5V Battery (AAA)	2 No.

In the event you find any Part missing or damaged, please contact your dealer immediately.

**SPECIFICATIONS**

**GENERAL SPECIFICATIONS :**

-  Maximum voltage including transient overvoltage between any terminals and grounding : 500V ms.
-  Display : 3/12 digits LCD display, Maximum display 1999
-  Auto Polarity Display
-  Overloading : Display **OL** or **-OL**
-  Battery Deficiency : Display “”
-  Measurement Speed : Update 3 times/second.
-  Measurement Deviation : When the conductor being measured is not placed in a correct position during AC current measurement. It will cause  $\pm 1\%$  reading deviation
-  Max. Jaw Size : 28mm diameter.
-  Projected Max. Current conductor size : 26mm diameter.
-  Power : 2pcs of 1.5V battery (AAA)
-  Sleep Mode (can be disabled)
-  Dimensions (LxWxH) : 208mm X 76mm X 30mm
-  Weight : Approximate 260g (battery Included)
-  Temperature and humidity : Operating 0°C~30°C (<75% R.H.) 30°C~40°C (<70%R.H.); 40°C~50° (<45%R.H.); Storage : -20°C~60°C (<75% R.H.)
-  Safety/ Compliances : IEC 61010 CAT.II 600V, CAT.III 300V over voltage and double insulation standard
-  Accessories : Carrying case, batteries installed, drop proof wrist strap, temperature probe operating manual, test leads.

**Electrical Specifications**

- Accuracy :  $\pm(\% \text{ reading} + \text{digits})$
- Operating temperature : 23°C $\pm$ 5°C
- Relative humidity : < 75% R.H.
- Temp. coefficient : 0.1 x (specified accuracy) / 1°C

**A. AC Current : Auto ranging**

Range	Resolution	Accuracy
2.000 A	0.001 A	$\pm(4\%rdg + 30dgts)$ 1A
		$\pm(3\%rdg + 12dgts)$
20.00 A	0.01 A	$\pm(3\%rdg + 12dgts)$ 4A
		$\pm(2\%rdg + 8dgts)$
200.0 A	0.1 A	$\pm(1.0\%rdg + 9dgts)$
400 A	1 A	

**Frequency Response** : 50Hz~60Hz

**Overload Protection** : 400A rms

Displays effective value of sine wave (mean value response).

To adjust reading in accordance with effective value.

**B. AC Voltage (Auto ranging)**

Range	Resolution	Accuracy
2.000 V	1 mV	$\pm(1.2\%rdg + 5dgts)$
20.00 V	10 mV	
200.0 V	100 mV	
600 V	1 V	$\pm(1.5\%rdg + 5dgts)$

**Overload protection**: 600V rms

**Input impedance** : 10M //<100pF

Display effective value of sine wave (mean value response).

**Frequency response** : 40Hz~1kHz.

To adjust reading in accordance with effective value.

**C. DC Voltage (Auto ranging)**

Range	Resolution	Accuracy
200.0 mV	0.1 mV	$\pm(0.8\%rdg+3dgt)$
2.000 V	1 mV	$\pm(0.8\%rdg+1dgt)$
20.00 V	10 mV	
200.0 V	100 mV	
600 V	1 V	$\pm(1\%rdg+3dgt)$

**Overload Protection** : 600V rms

**Input impedance** : 10M .

**D. Resistance (Auto Ranging)**

Range	Resolution	Accuracy
200.0	100 m	$\pm(1.2\%rdg+2dpts)$
2.000k	1	$\pm(1\%rdg+2dpts)$
20.00k	10	
200.0k	100	
2.000M	1 k	$\pm(1.2\%rdg+2dpts)$
20.00M	10 k	$\pm(1.5\%rdg+2dpts)$

**Overload Protection** : 600V rms.

**Input impedance** : 10M .

**E. Diode Test**

Range	Resolution	Accuracy
	1mV	Display Approx. forward voltage Drop: 0.5V~0.8V

**Overload Protection** : 600V rms

**Open circuit voltage** : approximate 1.48V.

**F. Temperature :**

Range	Resolution	Accuracy
-40~1000°C	1°C	-40~0°C: $\pm(3\%rdg+9dpts)$
		0~400°C: $\pm(1\%rds+7dpts)$
		400~1000°C: $\pm(2\%rdg+10dpts)$
-40°F~1832°F	1°F	-40~32°F: $\pm(3\%rdg+10dpts)$
		32°F~752°F: $\pm(1\%rds+8dpts)$
		752°F~1832°F $\pm(2\%rdg+18dpts)$

**Overload Protection** : 600V rms

Thermocouple accuracy not included  
Supplied Thermocouple is suitable for  
measurement upto 250°C.

**G. Continuity Test**

Range	Resolution	Accuracy
	100m	Around 50 the buzzer beeps

**Overload Protection** : 600V rms

**Open circuit voltage** : Approximate 0.45V.  
The buzzer may or may not beeps when the  
resistance of a circuit under test is between  
50 and 120  
The buzzer may not beep when the resistance  
of a circuit under test is greater than 120

## SAFETY INFORMATION

This Meter complies with the standards IEC61010 : in pollution degree 2, overvoltage category (CAT II 600V, CAT III 300V) and double insulation.

### CAT II :

Local level, appliance, PORTABLE EQUIPMENT etc., With smaller transient overvoltages than CAT III.

### CAT III :

Distribution level, fixed installation, with smaller transient overvoltages than CAT IV.

Use the Meter only as specified in this operating manual, otherwise the protection provided by the Meter may be impaired.

In this manual, a **Warning** identifies conditions & actions that pose hazards to the user, or may damage the Meter or the equipment under test.

A Note identifies the information that user should pay attention to.

International electrical symbols used on the Meter & in this operating manual are explained on page 8.

## RULES FOR SAFE OPERATION

### **Warning**













To avoid possible electric shock or personal injury, and to avoid possible damage to the Meter or to the equipment under test, adhere to the following rules :

- Before using the Meter inspect the case. Do not use the Meter if it is damaged or the case (or part of the case) is removed. Look for cracks or missing plastic. Pay attention to the insulation around the connectors.
- Inspect the test leads for damaged insulation or exposed metal. Check the test leads for Continuity. Replace damaged test leads with identical model number or electrical Specifications before using the Meter.
- Do not apply more than the rated voltage, as marked on the Meter, between the terminals or between any terminal and grounding. If the value to be measured is unknown, use the maximum measurement position and reduce the range step by step until a satisfactory reading is obtained.
- When measurement has been completed, disconnect the connection between the test leads and the circuit under test, remove the testing leads away from the input terminals of the meter and turn the meter power off.
- The rotary switch should be placed in the right position and no any changeover of range shall be made while measurement is conducted to prevent damage of the Meter.

- Do not carry out the measurement when the meter's back case and battery compartment are not closed to avoid electric shock.
- Do not input higher than 600V between the Meter's terminals and the grounding to avoid electric shock and damages to the Meter.
- When the meter working at an effective voltage over 60V in DC or 30V rms in AC, special care should be taken for there is danger of electric shock.
- Use the proper terminals, function, and range for your measurements.
- Do not use or store the meter in an environment of high temperature, humidity, explosive, inflammable and strong magnetic field. The performance of the meter may deteriorate after the meter gets dampened.
- When using the test leads, keep your fingers behind the finger guards.
- Disconnect circuit power and discharge all high-voltage capacitors before testing resistance, continuity and diode or current.
- Replace the battery as soon as the low battery indicator  appears. With a low battery, the Meter might produce false readings that can lead to electric shock and personal injury.
- When servicing the meter, use only the same model number or identical electrical specifications replacement parts.

- The internal circuit of the meter shall not be altered at will to avoid damage of the meter and any accident.
- Soft cloth and mild detergent should be used to clean the surface of the meter when servicing. No abrasive and solvent should be used to prevent the surface of the meter from corrosion, damage and accident.
- The meter is suitable for indoor use.
- Turn the meter off when it is not in use and take out the battery when not using for a long time.
- Constantly check the battery as it may leak when it has not been used for some time, replace the battery as soon as leaking appears. A leaking battery will damage the meter.

**International Electrical Symbols**

	AC (Alternating Current).
	DC (Direct Current).
	Both DC & AC.
	Grounding.
	Double Insulated.
	Deficiency of Built-In Battery.
	Continuity Test.
	Diode.
	Capacitance Test
	Fuse.
	Warning ! Refer to the Operating Manual.
	Conforms to Standards of European Union
	Caution ! Risk of Electric shock.

**THE CLAMP METER STRUCTURE**

(see figure 1)

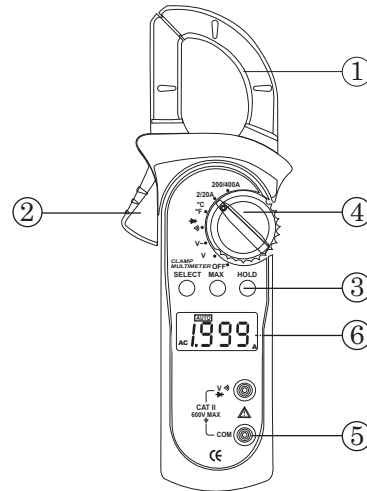

- 1) **TRANSFORMER JAWS :**  
Pick up the AC current flowing through the conductor.
- 2) **TRIGGER :**  
Press the lever to open the transformer jaws  
When the lever is released, the jaws will close again.
- 3) **FUNCTIONAL BUTTON :**  
To perform various functions like function selection, Data Hold, Max Hold.
- 4) **FUNCTION SELECTOR SWITCH :**  
To Select ACV, ACA, DCV, RESISTANCE, DIODE & CONTINUITY TEST, TEMPERATURE.

**5) INPUT JACKS (V and COM) :**

Test leads are inserted into these jacks for Voltage, Resistance, Temperature measurements and Continuity & Diode Checks.

**6) LCD DISPLAY :**

A 3½ digit display (maximum reading 1999) indicates measured values, and features symbols indicating function, Data - Hold, Low Battery, Continuity, Diode.

**Rotary Switch**

Below table indicated for information about the rotary switch positions.

Rotary Switch Position	Function
OFF	Power is turned off
V	AC / DC voltage measurement
	: Diode Test
	: Continuity Test
W	W : Resistance Measurement
°C°F	Temperature Measurement
A~	AC Current Measurement range from 0.001A to 400.0A

**FUNCTIONAL BUTTONS**

Below table indicates the functional button Operations

Switch	Operation Performed
<b>HOLD</b> (Yellow Button)	Press HOLD  to enter and exit the Hold Mode in any mode, the meter beeps. Press and HOLD  button while turning on the meter to display full icons.
<b>MAX</b> (Black Button)	Press MAX to start recording and updating of maximum values
<b>Select</b> (Blue Button)	Press SELECT button to switch between  and °C °F

**The Effectiveness of Functional Buttons**

Not every functional buttons can be used on every rotary switch positions. Below two tables describe which functional buttons can be used on which rotary switch positions

Rotary Switch Position	Functional Buttons		
	SELECT	MAX	HOLD
V	N/A	●	●
V	N/A	●	●
	●	N/A	●
°F°C (K-Type)	●	N/A	●
A~ 2/20A	N/A	●	●
A~ 200/400A	N/A	●	●



**DISPLAY SYMBOLS** (see figure 2)

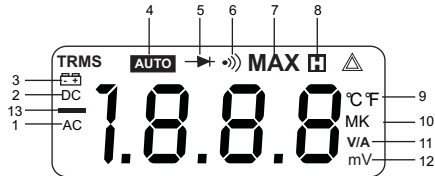

14 (figure 2)

No.	Symbol	Meaning
1	AC	Indicator for AC Voltage or Current.
2	DC	Indicator for DC Voltage
3		The battery is low. Warning : To avoid false readings, which could lead to possible electric shock or personal injury, replace the battery as soon as the battery indicator appears.
4	<b>Auto</b>	The Meter is in auto range mode in which the Meter automatically selects the range with the best resolution.
5		Test of diode.
6	<b>H</b>	Data hold is active.
7		The continuity buzzer is on.
8	<b>MAX</b>	Maximum reading displayed.
9	°C °F	The unit of temperature °C : Centigrade temperature °F : Fahrenheit temperature
10	, K , M	: Ohm. The unit of resistance. K : kilo-ohm. $1 \times 10^3$ or 1000 ohms. M : Megaohm. $1 \times 10^6$ or 1,00,000 ohms.

No.	Symbol	Meaning
11	A	Amperes (amps). The unit of current.
12	mV, V	Volts. The unit of voltage mV; Millivolt $1 \times 10^{-3}$ or 0.001 volts
13		Indicates negative readings
14	OL	The input value is too large for the selected range.

**MEASUREMENT OPERATION**

**A. AC Current Measurement (see figure 9)**



(figure 9)

**Warning**

To avoid electric shock, never measure current while the test leads are inserted into the input terminals and disconnect test leads and tested circuit connection.

Never attempt an in-circuit current measurement where the open-circuit voltage between the circuit and the ground is greater than 600V.

Use proper function and range for the measurement.

The measurement range of current are :  
2.000A, 20.00A, 200.0A and 400A.

To measure current, connect the meter as follows :

1. Set the rotary switch 2/20A~ or 200/400 A~
2. Press the lever to open the transformer jaws.
3. Centre the conductor within the transformer jaw.  
The measured value is shown on the display, it is an effective value of sine wave (mean value response).

**Caution**

- To obtain accurate reading, measure only one conductor at each time.
- When current measurement has been completed, disconnect the connection between the conductor under test and the jaw, and remove the conductor away from the transformer jaw of the Meter.

**B. DC Voltage Measurement (see figure 3)**

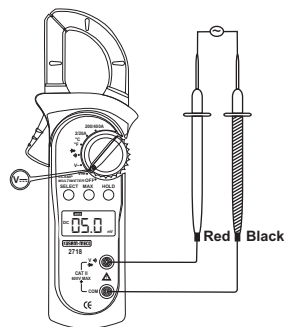

(figure 3)

**Warning**

To avoid harms to you or damages to the Meter from electric shock, do not attempt to measure voltage higher than 600V AC/DC, although reading may be obtained.

The DC Voltage ranges are :  
200.0mV, 2.000V, 20.00V, 200.0V and 600V.

To measure DC Voltage, connect the Meter as follows :

1. Insert the red test lead into the  $\rightarrow V$  terminal and the black test lead into the COM terminal.
2. Set the rotary switch to  $V \text{ ---}$  position.

3. Connect the test leads across with the object being measured  
The measured value is shown on the display.

**⚠ Caution**

In each range, the Meter has an input impedance of 10M. This loading effect can cause the measurement errors in high impedance circuits. If the circuit impedance is less than or equal to 10k, the error is negligible (0.1 or less).

**When DC voltage measurement has been completed, disconnect the connection between the testing leads and the circuit under test and remove testing leads from the input terminals.**

**C. AC Voltage Measurement (see figure 4)**

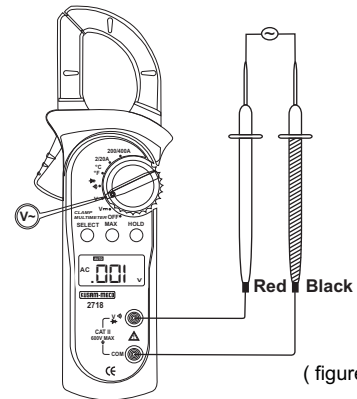

**⚠ Warning**

**To avoid harms to you or damages to the Meter from electric shock, do not attempt to measure voltage higher than 600V AC/DC, although readings may be obtained**

The AC Voltage range are :  
2.000V, 20.00V, 200.0V and 600V

To measure AC voltage, connect the Meter as follows:

1. Insert the red test lead into the «V~» → **V** terminal & the black test lead into the **COM** terminal.
2. Set the rotary switch to **V~** position.
3. Connect the test leads across with the object being measured.

The measured value is shown on the display.

**⚠ Caution**

In each range, the Meter has an input impedance of 10 M $\Omega$ . This loading effect can cause measurement errors in high impedance circuits. If the circuit impedance is less than or equal to 10k $\Omega$ , the error is negligible (0.1 or less).

When AC Voltage measurement has been completed, disconnect the connection between the testing leads and the circuit under test and remove testing leads from the input terminals.

**D. Measuring Resistance** (see figure 5)

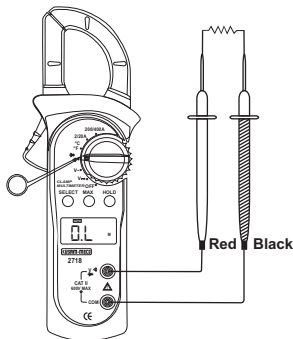

( figure 5)

**⚠ Warning**

**To avoid harms to you, do not attempt to input voltages higher than 60V DC or 30V rms AC.**

**To avoid damages to the Meter or to the devices under test, disconnect circuit power & discharge all the high-voltage capacitors before measuring resistance.**

The resistance ranges are :

200.0 , 2.00k , 20.00k , 200k , 2.000M and 20.00M

To measure resistance, connect the Meter as follows :

1. Insert the red test lead into the  $\rightarrow V$  terminal and the black test lead into the **COM** terminal.
2. Set the rotary switch to  $\rightarrow \Omega$   $\rightarrow \rightarrow$  resistance measurement (  $\Omega$  ) is default or press **SELECT** button to select resistance measurement mode.
3. Connect the test leads across with the object being measured.

The measured value is shown on the display.

**Note :**

The test leads can add 0.1 to 0.3  $\Omega$  of error to resistance measurement.

- For high-resistance measurement ( $>1M\Omega$ ), it is normal for the meter to take several seconds to obtain a stable reading.
- If reading with shorted test leads is not 0.5  $\Omega$ , check for loose test leads, wrong function selected, or enabled data hold function.
- The LCD displays OL indicating open-circuit or the tested resistor value is higher than the maximum range of the meter.
- Resistance measurement is default to auto range mode.
- To Remove the objects being tested from the circuit when measuring, to obtain more accurate result.
- When resistance measurement has been completed, disconnect the connection between the testing leads and the circuit under test and remove testing leads from the input terminals.

**E. Testing Diodes** (see figure 6)

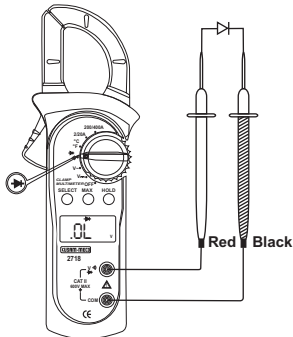

( figure 6)

**Warning**

**To avoid damages to the Meter or to the devices under test, disconnect circuit power and discharge all the high-voltage capacitors before testing diodes.**

Use the diode test to check diodes, transistors and other semiconductor devices. The diode test sends a current through the semiconductor junction, then measure the voltage drop across the junction. A good silicon junction drops between 0.5V and 0.8V.

To test the diode out of a circuit, connect the Meter as follows :

1. Insert the red test lead into the  $\rightarrow \text{V}$  terminal and the black test lead into the **COM** terminal.
2. Set the rotary switch to  $\rightarrow \text{V}$  & press **SELECT** button to select diode measurement mode.
3. For forward voltage drop readings on any semiconductor component, place the red test lead on the component's anode and place the black test lead on the components cathode.

**Caution**

In a circuit, a good diode should still produce a forward voltage drop reading of 0.5V to 0.8; however, the reverse voltage drop reading can vary depending on the resistance of the pathways between the probe tips.

- Connect the test leads to the proper terminals as said above to avoid error display.
- The LCD will display OL indicating either open circuit or wrong polarity connection.
- The unit of diode is volt (V), displaying the forward voltage drop readings.
- To remove the object being tested from the circuit when measuring, to obtain a more accurate result.
- When diode testing has been completed, disconnect the connection between the testing leads and the circuit under test and remove testing leads from the input terminals.

**F. Testing for continuity** (see figure 7)

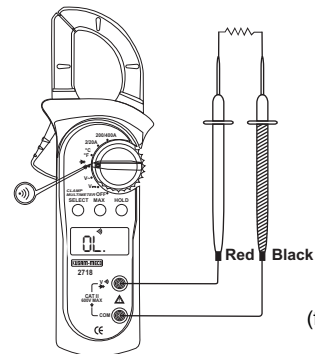

(figure 7)



**Warning**

To avoid damages to the Meter or to the devices under test, disconnect circuit power and discharge all the high-voltage capacitors before measuring continuity.

To test for continuity, connect the Meter as follows :

1. Insert the red test lead into the «)» →→ V terminal and the black test lead into the COM terminal.
2. Set the rotary switch to «)» →→ and press **SELECT** button to select continuity measurement mode.
3. The buzzer sounds if the resistance of a circuit under test is less than 50
4. The buzzer may or may not sounds if the resistance of circuit under test is between 50 to 120 .
5. The buzzer does not sound if the resistance of a circuit under test is higher than 120 .

**Note**

- ✎ The buzzer beeps once when pressing any buttons at any rotary switch positions except at 2/20A positions if the button is valid. If the button is not valid, it does not beep. At 2/20A rotary switch position, the buzzer is set not to beep.
- ✎ The buzzer beeps 5 times continuously on around 1 minute before entering the sleep mode. When it is just before entering the sleep mode, it will have one long beep to warn you.
- ✎ The LCD displays **OL** indicating the circuit being tested is open.
- ✎ When continuity testing has been completed, disconnect the connection between the testing leads and the circuit under test and remove testing leads from input terminal.

**G. Temperature Measurement**

(see figure 8)

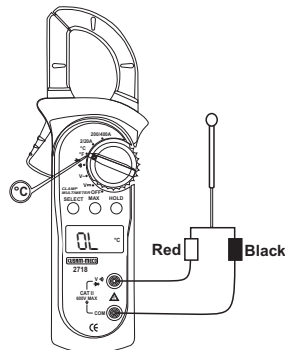

(figure 8)

The temperature measurement ranges are -40°C~1000°C and -40°F~1832°F.

To measure temperature, connect the Meter as follows :

1. Insert the red temperature probe into the «)» →→ V terminal and the black temperature probe in the COM terminal.
2. Set the rotary switch to °F/°C and press **SELECT** button to select °F or °C measurement mode. °C measurement mode is default.
3. Place the temperature probe to the object being measured. The measured value shows on the display.

**Note**

- ✎ The Meter automatically displays the ambient temperature value inside the Meter when there is no temperature probe connection.
- ✎ When temperature measurement has been completed, disconnect the connection between the temperature probe and the circuit under test and remove the temperature probe away from the input terminals of the Meter.

### Sleep Mode

To preserve battery life, the Meter automatically turns off if you do not turn the rotary switch or press any button for around 15 minutes.

The meter can be activated by turning the rotary switch or pressing any button with the following conditions:

- 1) When the Meter has entered Sleep Mode at temperature functions, Meter cannot be activated by turning the rotary switch to AC current ranges.
- 2) By pressing any button must be according to “**The Effectiveness of Functional Buttons**” on page 11.
- 3) The Hold function will be cancelled if the Meter is activated by pressing the **HOLD** button.

To disable the Sleep Mode function, press and hold **HOLD** button while turning on the Meter.





### MAINTENANCE

This section provides basic maintenance information including battery replacement instruction.

#### Warning

**Do not attempt to repair or service your Meter unless you are qualified to do so and have the relevant calibration, performance test and service information.**  
**To avoid electrical shock or damage to the Meter, do not get water inside the case.**

#### A. General Service

-  Periodically wipe the case with a damp cloth and mild detergent. Do not use abrasives or solvents.
-  To clean the terminals with cotton bar with detergent as dirt or moisture in the terminals can affect readings.
-  Turn the Meter power off when it is not in use.
-  Take out the battery when it is not using for a long time
-  Do not use or store the Meter in a place of humidity, high temperature, explosive, inflammable and strong magnetic field.

#### B. Replacing the Battery (see figure 10)

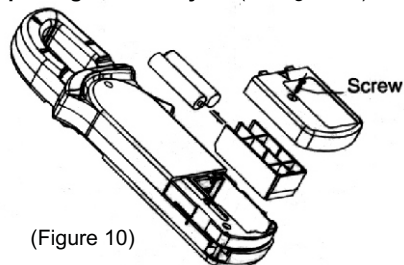

(Figure 10)

**Warning**

To avoid false readings, which could lead to possible electric shock or personal injury, replace the battery as soon as the battery indicator “” appears.

**Make sure the transformer jaw and the test leads are disconnected from the circuit being tested before opening the case bottom.**

**To replace the battery :**

1. Turn the Meter off and remove all the connections from the input terminals.
2. Turn the Meter's case top down.
3. Remove the screw from the battery compartment, and separate the battery compartment from the case bottom.
4. Remove the old battery from the battery compartment.
5. Replace the battery with 2pcs of new 1.5V (AAA) battery.
6. Rejoin the case bottom and the battery compartment, and reinstall the screw.

MUMBAI  
**TEST CERTIFICATE**  
**DIGITAL CLAMP METER**

This Test Certificate warrants that the product has been inspected and tested in accordance with the published specifications.

The instrument has been calibrated by using equipment which has already been calibrated to standards traceable to national standards.

MODEL NO. 2718

SERIAL NO. \_\_\_\_\_

DATE: \_\_\_\_\_

ISO 9001  
REGISTERED





**KUSAM-MECO**

### **WARRANTY**

Each "KUSAM-MECO" product is warranted to be free from defects in material and workmanship under normal use & service. The warranty period is one year (12 months) and begins from the date of despatch of goods. In case any defect occurs in functioning of the instrument, under proper use, within the warranty period, the same will be rectified by us free of charges, provided the to and fro freight charges are borne by you.

This warranty extends only to the original buyer or end-user customer of a "KUSAM-MECO" authorized dealer.

This warranty does not apply for damaged Ic's, fuses, burnt PCB's, disposable batteries, carrying case, test leads, or to any product which in "KUSAM-MECO's" opinion, has been misused, altered, neglected, contaminated or damaged by accident or abnormal conditions of operation or handling.

"KUSAM-MECO" authorized dealer shall extend this warranty on new and unused products to end-user customers only but have no authority to extend a greater or different warranty on behalf of "KUSAM-MECO".

"KUSAM-MECO's" warranty obligation is limited, at option, free of charge repair, or replacement of a defective product which is returned to a "KUSAM-MECO" authorized service center within the warranty period.

**KUSAM-MECO**

THIS WARRANTY IS BUYER'S SOLE AND EXCLUSIVE REMEDY AND IS IN LIEU OF ALL OTHER WARRANTIES, EXPRESS OR IMPLIED, INCLUDING BUT NOT LIMITED TO ANY IMPLIED WARRANTY OF MERCHANTABILITY OR FITNESS FOR A PARTICULAR PURPOSE. "KUSAM-MECO" SHALL NOT BE LIABLE FOR ANY SPECIAL, INDIRECT, INCIDENTAL OR CONSEQUENTIAL DAMAGES OR LOSSES, INCLUDING LOSS OF DATA, ARISING FROM ANY CAUSE WHATSOEVER.

All transaction are subject to Mumbai Jurisdiction.

**KUSAM-MECO**

G 17, Bharat Industrial Estate, T. J. Road,  
Sewree (W), Mumbai - 400 015. INDIA.

**Sales Direct :** (022) 24156638

**Tel. :** (022) 24124540, 24181649.

**Fax :** (022) 24149659

**Email :** kusam\_meco@vsnl.net

**Website :** www.kusamelectrical.com,  
www.kusam-meco.co.in